

2023

KATALOG-2

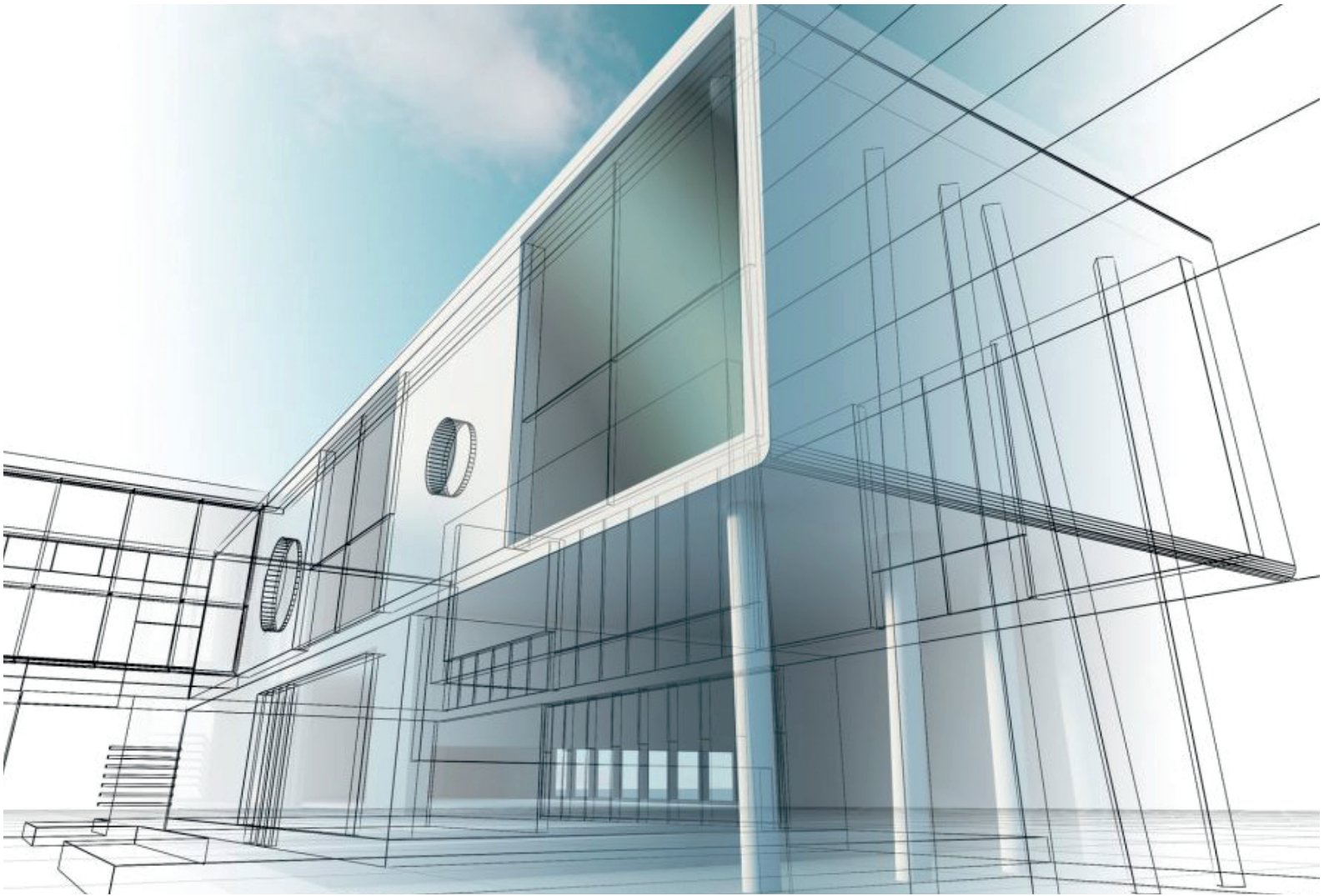

**YOUNG REFERANS KATALOĐU / 2023**  
[WWW.YOUNGALUMINYUM.COM](http://WWW.YOUNGALUMINYUM.COM)



**YOUNG**  
alüminyum

# KIŞ BAHÇESİ SİSTEMİ

*Winter Garden System*



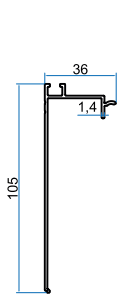

Proile No	kg/m
YNG2533	0,600

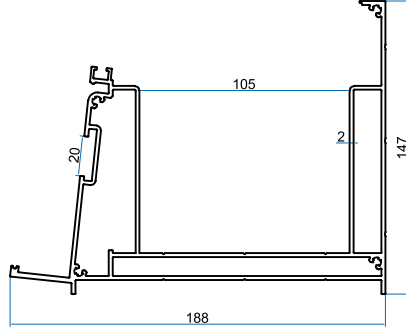

Proile No	kg/m
YNG2530	4,721

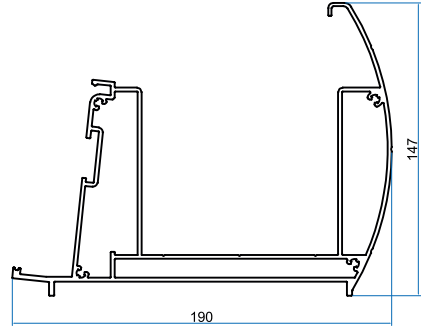

Proile No	kg/m
YNG2594	4,618

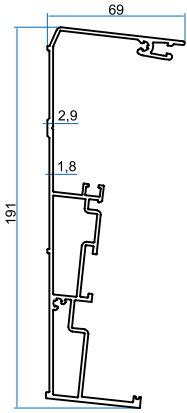

Proile No	kg/m
YNG2532	2,651

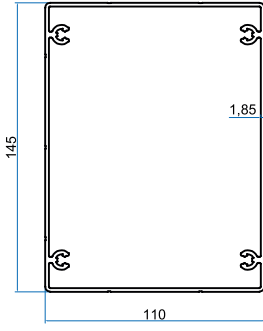

Proile No	kg/m
YNG2111	3,044

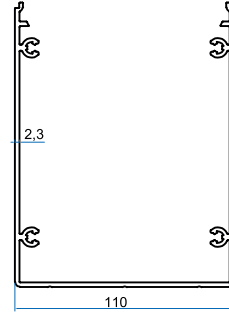

Proile No	kg/m
YNG2301	3,033

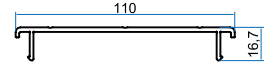

Proile No	kg/m
YNG2302	0,846

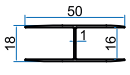

Proile No	kg/m
YNG2539	0,290



Proile No	kg/m
YNG2538	0,210



Proile No	kg/m
YNG2542	0,180

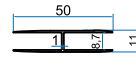

Proile No	kg/m
YNG2543	0,230

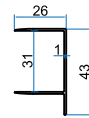

Proile No	kg/m
YNG2544	0,240

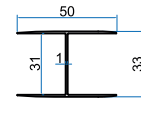

Proile No	kg/m
YNG2545	0,285

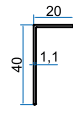

Proile No	kg/m
YNG2394	0,177

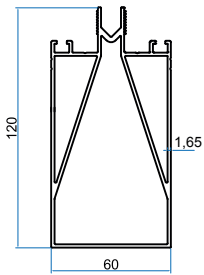

Proile No	kg/m
YNG2935	1,721

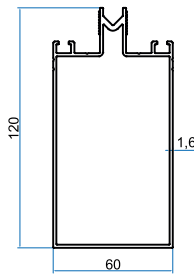

Proile No	kg/m
YNG2490	1,721

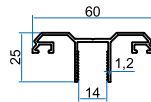

Proile No	kg/m
YNG2534	0,515

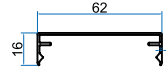

Proile No	kg/m
YNG2535	0,312

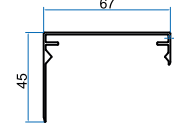

Proile No	kg/m
YNG2536	0,415

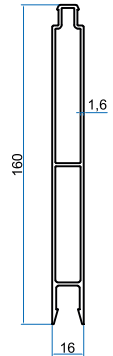

Proile No	kg/m
YNG2546	1,591



**Kış Bahçesi Arka Askı**  
*Winter Garden Rear Hanger*

**Product Code : YNG-2532**

**Weight kg/m: 2,651**  
(191 x 69 x 1,8mm)



**Kış Bahçesi 110x145 Direk**  
*Winter Garden 110x145 Column*

**Product Code : YNG-2111**

**Weight kg/m: 3,044**  
(145 x 110 x 1,85mm)



**Kış Bahçesi 110x145 Direk Kapak**  
*Winter Garden 110x145 Column Cover*

**Product Code : YGN-2302**

**Weight kg/m: 0,846**  
(17 x 110 x 2,3mm)



**Kış Bahçesi 110x145 Direk Gövde**  
*Winter Garden 110x145 Column*

**Product Code : YGN-2301**

**Weight kg/m: 3,003**  
(143 x 110 x 2,3mm)



**Kış Bahçesi Düz Oluk**  
*Winter Garden Gutter*

**Product Code: YNG-2530**

**Weight kg/m: 4,721**  
*(147 x 188 x 2mm)*



**Kış Bahçesi Radüs Oluk**  
*Winter Garden Radius Gutter*

**Product Code: YNG-2594**

**Weight kg/m: 4,700**  
*(147 x 190 x 2mm)*



**Kış Bahçesi Kenar Kapak**  
**(Sağ ve Sol)**  
*Winter Garden Edge Cover*  
*(Right and Left)*

**Product Code: YNG-2536**

**Weight kg/m: 0,415**  
*(45 x 63 x 1mm)*

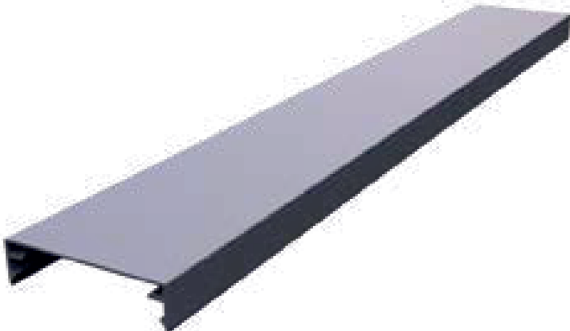

**Kış Bahçesi Üst Kapak**  
*Winter Garden Top Cover*

**Product Code: YNG-2535**

**Weight kg/m: 0,312**  
*(16 x 62 x 1mm)*



**Kış Bahçesi Cam Kapak**  
*Winter Garden Glass Cover*

**Product Code: YNG-2534**

**Weight kg/m: 0,515**  
(25 x 60 x 1,2mm)



**Kış Bahçesi Cam Tutucu**  
*Winter Garden Glass Holder*

**Product Code: YNG-2490**

**Weight kg/m: 1,721**  
(120 x 60 x 1,6mm)



**Kış Bahçesi Köşebent**  
*Winter Garden Bracket*

**Product Code: YNG-2394**

**Weight kg/m: 0,177**  
(40 x 20 x 1,1mm)



**Kış Bahçesi Oluk ve Arka İç Kapak**  
*Winter Garden Gutter and Rear Inner Cover*

**Product Code: YNG-2533**

**Weight kg/m: 0,600**  
(105 x 36 x 1,4mm)



**15x160 Lambiri**  
*15x160 Paneling*

**Product Code: YNG-2546**

**Weight kg/m: 1,591**  
*(160 x 16 x 1,6mm)*

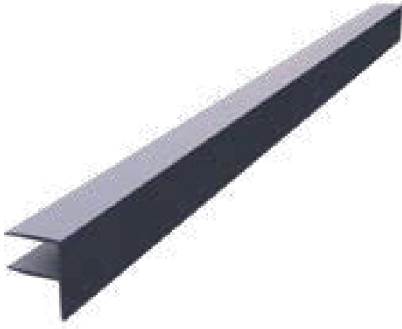

**8mm F Proil**  
*8mm F Proile*

**Product Code: YNG-2542**

**Weight kg/m: 0,180**  
*(21 x 26 x 1mm)*



**8mm H Proil**  
*8mm H Proile*

**Product Code: YNG-2543**

**Weight kg/m: 0,230**  
*(11 x 50 x 1mm)*

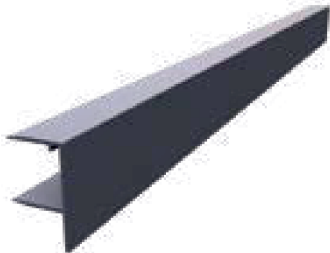

**16mm F Proil**  
*16mm F Proile*

**Product Code: YNG-2538**

**Weight kg/m: 0,210**  
*(28,5 x 26 x 1mm)*



**16mm H Proil**  
*16mm H Proile*

**Product Code: YNG-2539**

**Weight kg/m: 0,290**  
*(16 x 50 x 1mm)*

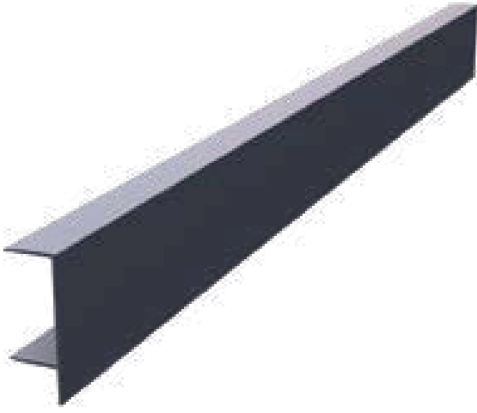

**24mm F Proil**  
*24mm F Proile*

**Product Code: YNG-2544**

**Weight kg/m: 0,240**  
*(43 x 26 x 1mm)*



**24mm H Proil**  
*24mm H Proile*

**Product Code: YNG-2545**

**Weight kg/m: 0,285**  
*(33 x 50 x 1mm)*



**Kış Bahçesi Cam Tutucu**  
*Winter Garden Glass Holder*

**Product Code: YNG-2935**

**Weight kg/m: 2,440**  
*(120 x 60 x 1,6mm)*



# TENTE PROFİL SİSTEMLERİ

## *Awning Profile System*



Proile No	kg/m
YNG2337	4,560

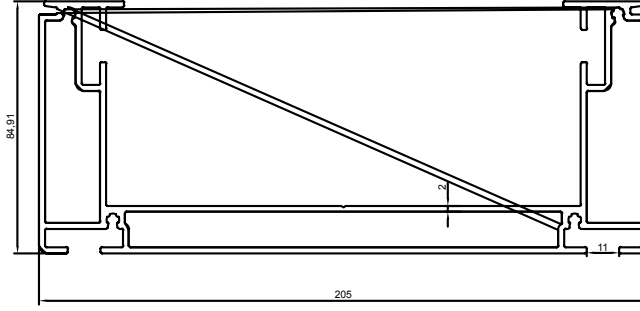

Proile No	kg/m
YNG2338	1,730

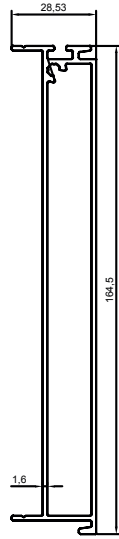

Proile No	kg/m
YNG2339	7,827

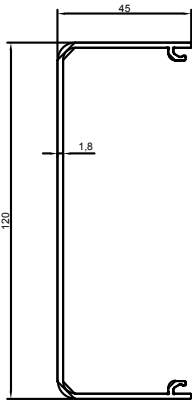
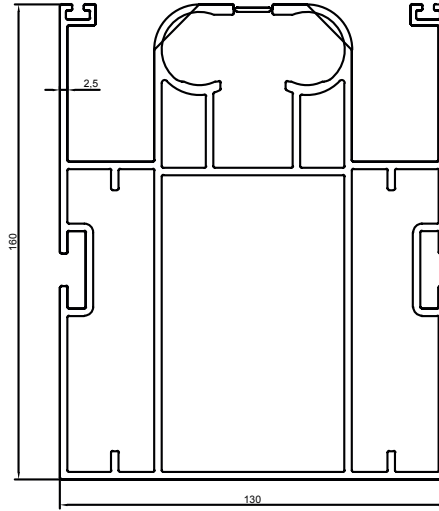

Proile No	kg/m
YNG2342	1,055

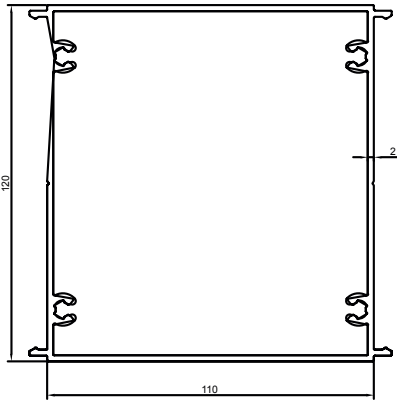

Proile No	kg/m
YNG2341	3,028

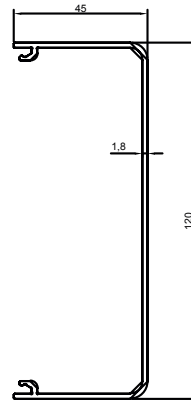

Proile No	kg/m
YNG2342	1,055

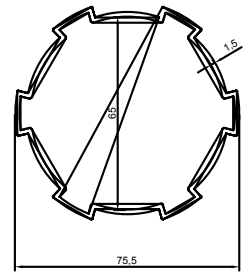

Proile No	kg/m
YNG5312	1,100

Proile No	kg/m
YNG2340	3,906

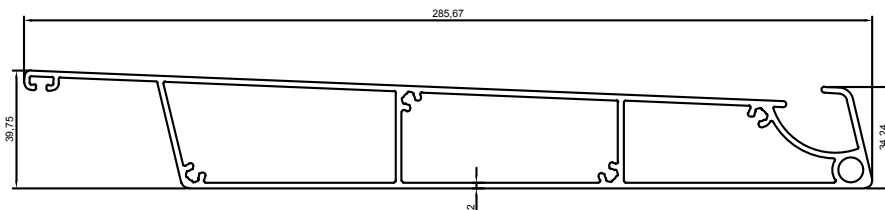

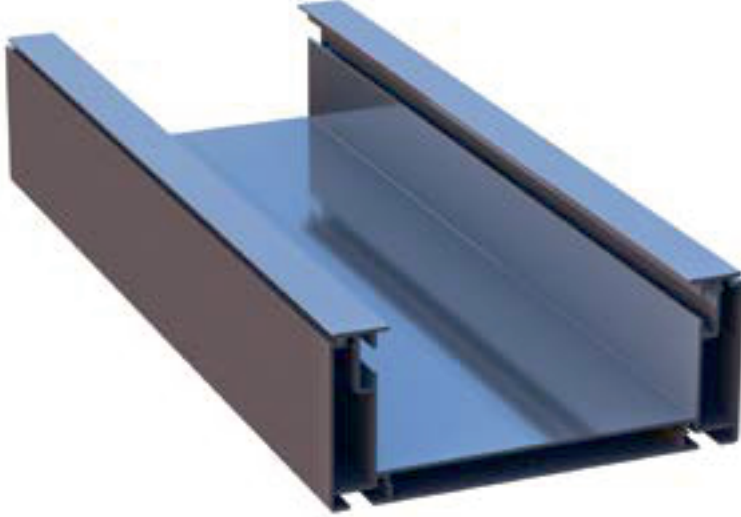

**Oluk Proili**  
*Gutter Profile*

**Product Code: YNG-2337**

**Weight kg/m: 4,560**  
**Size : 205x85x2 mm**



**Oluk Ön/Arka Kapama Proili**  
*Gutter Front / Rear Closure Profile*

**Product Code: YNG-2338**

**Weight kg/m: 1,730**  
**Size : 29x165x1,6 mm**



**Ray Proili**  
*Rail Profile*

**Product Code: YNG-2339**

**Weight kg/m: 7,827**  
**Size : 130x160x2,5 mm**

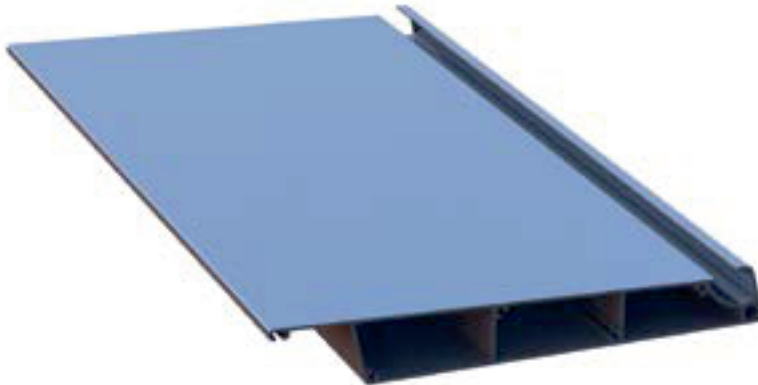

**Lamel Proili**  
*Lamella Profiles*

**Product Code: YNG-2340**

**Weight kg/m: 3,906**  
**Size : 40x286x2 mm**



**Dikme Proili**  
*Sewing Proile*

**Product Code:** YNG-2341

**Weight kg/m:** 3,028  
**Size :** 110x120x2 mm

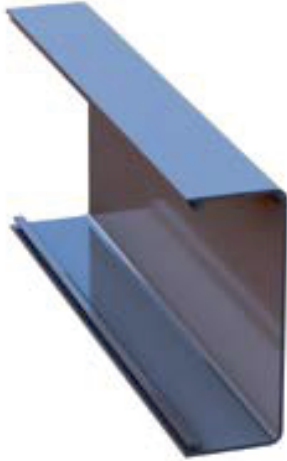

**Dikme Kapak Proili**  
*Sewing Cover Proile*

**Product Code:** YNG-2342

**Weight kg/m:** 1,055  
**Size :** 45x120x1,8 mm

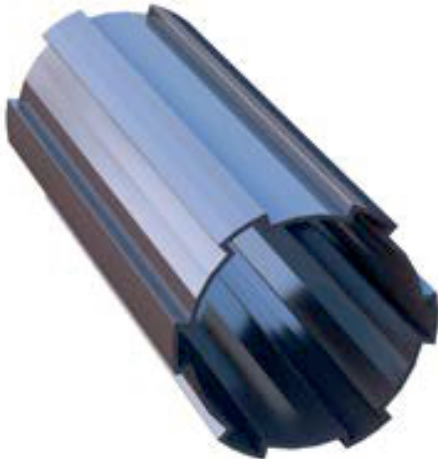

**Motor Borusu**  
*Motor Pipe*

**Product Code:** YNG-5312

**Weight kg/m:** 1,100  
**Size :** Ø 75,5x1,5 mm

## ROLLING ROOF AKSESUARLARI / ROLLING ROOF ACCESSORIES



Ray Takımı  
Rail Set  
Product Code: YGN-01

## KOLI İÇ TAKIM ADETLERİ / PIECES IN THE BOX

Roll-01	Ürün Adı / Product Name	Koli Adeti / Box
YNG-01-1	Arka Plastik Rulman Yatağı Sağ/Sol / Rear Plastic Bearing Right / Left	1 takım / set
YNG-01-2	T10 triger Dişli / T10 timing Gear	1 adet / piece
YNG-01-3	Triger Kayış Fren / Timing Belt Brake	1 adet / piece
YNG-01-4	6917 Çelik Rulman / 6917 Steel Bearing	2 adet / piece
YNG-01-5	Ön Rulman Yataklama Plastiği / Front Roller Bearing Plastic	1 takım / set
YNG-01-6	Ön Gergi Plastik Dış Kasa Sağ/Sol / Front Tension Plastic Outer Case Right / Left	1 takım / set
YNG-01-7	6007 Çelik Rulman / 6007 Steel Bearing	2 adet / piece
YNG-79	16x16 Kare Lama M8 Dişli / 16x16 Square Flat Bar M8	1 adet / piece
YNG-01-9	Ön Gergi Teker ve Triger Bağlantı Plastiği / Front Tensioner Wheel and Timing Link Plastic	1 takım / set
YNG-08	75'Lik Su Gideri / 75 'Water Drain	1 adet / piece
YNG-01-11	Ray Arka Duvar Bağlantı Aparatı / Rail Rear Wall Connection Apparatus	1 adet / piece
YNG-01-12	Ray Arka (U) Bağlantı Aparatı / Rail Rear (U) Connection Apparatus	1 adet / piece
YNG-01-13	Arka 4. Lamel Bağlatı Aparatı / Rear 4 Th Lamella Fixing Apparatus	2 adet / piece
YNG-01-14	Ön Ray Oluk Bağlantı Aparatı / Front Rail Groove Connection Apparatus	1 adet / piece
YNG-01-15	Ayak Alt Üst Bağlantı Aparatı / Foot Lower Upper Connection Apparatus	1 takım / set
YNG-01-16	40x100 Duvar Askı Aparatı / 40x100 Wall Hanger Apparatus	1 adet / piece
YNG-01-17	Ray Arka Bağlantı Laması (M8 4 Delikli 25x100) / Rail Rear Connection Plate (M8 4 Holes 25x100)	2 adet / piece
YNG-01-18	Ray Ön Ve Ayak Bağlantı Laması (M8 2 Delikli 25x20) / Rail Front and Foot Connection Plate (M8 2 Holes 25x20)	3 adet / piece
YNG-01-19	Ray Ön Oluk Bağlantı Laması (M8 2 Delikli 25x25) / Rail Front Groove Connection Plate (M8 1 Hole 25x25)	2 adet / piece
YNG-01-20	M12x160 AKV Cıvata / M12x160 AKV Bolt / Box Piece: 100	2 adet / piece
YNG-01-21	M8x16 Yuvarlak Başlı Kare Vida / M8x16 Round Head Square Screw / Box Piece: 2500	2 adet / piece
YNG-01-22	M8x70 İnbüs Cıvata / M8x70 İnbüs Bolt / Box Piece: 200	2 adet / piece
YNG-01-23	M8x12 Bombe Baş İnbüs Cıvata / M8x12 Round Head İnbüs Bolt / Box Piece: 2500	20 adet / piece
YNG-01-24	M6x90 İnbüs Cıvata / M6x90 İnbüs Bolt / Box Piece: 100	2 adet / piece
YNG-01-25	M6x70 İnbüs Cıvata / M6x70 İnbüs Bolt / Box Piece: 200	2 adet / piece
YNG-01-26	M6x50 İnbüs Cıvata / M6x50 İnbüs Bolt / Box Piece: 200	1 adet / piece
YNG-01-27	M12 Fiberli Somun / M12 Fiber Nut / Box Piece: 300	2 adet / piece
YNG-21	M8 Fiberli Somun / M8 Fiber Nut / Box Piece: 1000	6 adet / piece
YNG-01-29	M6 Fiberli Somun / M6 Fiber Nut / Box Piece: 250	5 adet / piece
YNG-01-30	6,3x32 YHB Saç Vidası / 6,3x32 YHB Hair Screw / Box Piece: 300	8 adet / piece

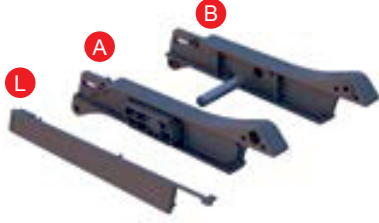

**Lamel Sol Kapak Plastik**  
*Lamel Left Cover Plastic*  
Product Code: YNG-02  
Box Piece: 50 set

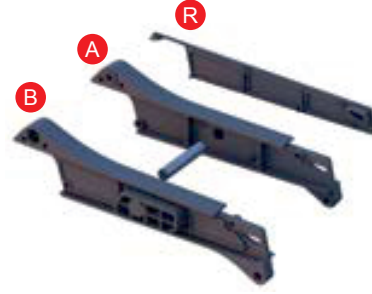

**Lamel Sağ Kapak Plastik**  
*Lamel Right Cover Plastic*  
Product Code: YNG-03  
Box Piece: 50 set



**Arka Lamel Sabitleme (Orta)**  
*Rear Lamel Fixing (Middle)*  
Product Code: YNG-05



**Arka Lamel Sabitleme (Kenar)**  
*Rear Lamel Fixing (Side)*  
Product Code: YNG-04



**Ön Lamel Mafsalı Sağ/Sol**  
*Front Lamella Joint Right / Left*  
Product Code: YNG-06



**Orta Lamel Mafsalı Sağ/Sol**  
*Middle Lamella Joint Right / Left*  
Product Code: YNG-07  
Box Piece: 100 piece



**Arka Lamel Mafsalı Sağ/Sol**  
*Rear Lamella Joint Right / Left*  
Product Code: YNG-08



**Küçük Teker**  
*Small Wheel*  
Product Code: YNG-09  
Box Piece: 125 piece



**Orta Ray Teker Mafsalı**  
*Middle Rail Wheel Joint*  
Product Code: YNG-10



**Oluk Sağ/Sol Kapak Aparatı**  
*Gutter Right/Left Cover Plate*  
Product Code: YNG-11



**Motor Sabitleme Aparatı**  
*Motor Fixing Apparatus*  
Product Code: YNG-44



**Somfy Pergola Motor Aparatı**  
*Somfy Pergola Engine Apparatus*  
Product Code: YNG-18  
Box Pices: 50 set

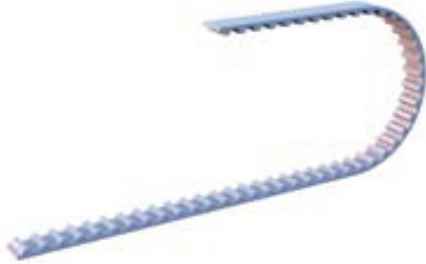

**T10/16 Triger Kayış**  
*T10/16 Timing Belt*  
Product Code: YNG-105  
1 Roll: 100 mt  
1 Roll: 100 mt



**Lamel Epdm Panel Contası**  
*Epdm Panel Gasket*  
Product Code: YNG-15  
1 Roll: 161 m / 15 kg



**Ray ve Oluk Epdm Contası**  
*Epdm Rail Gasket*  
Product Code: YNG-16  
1 Roll: 57 m / 15 kg



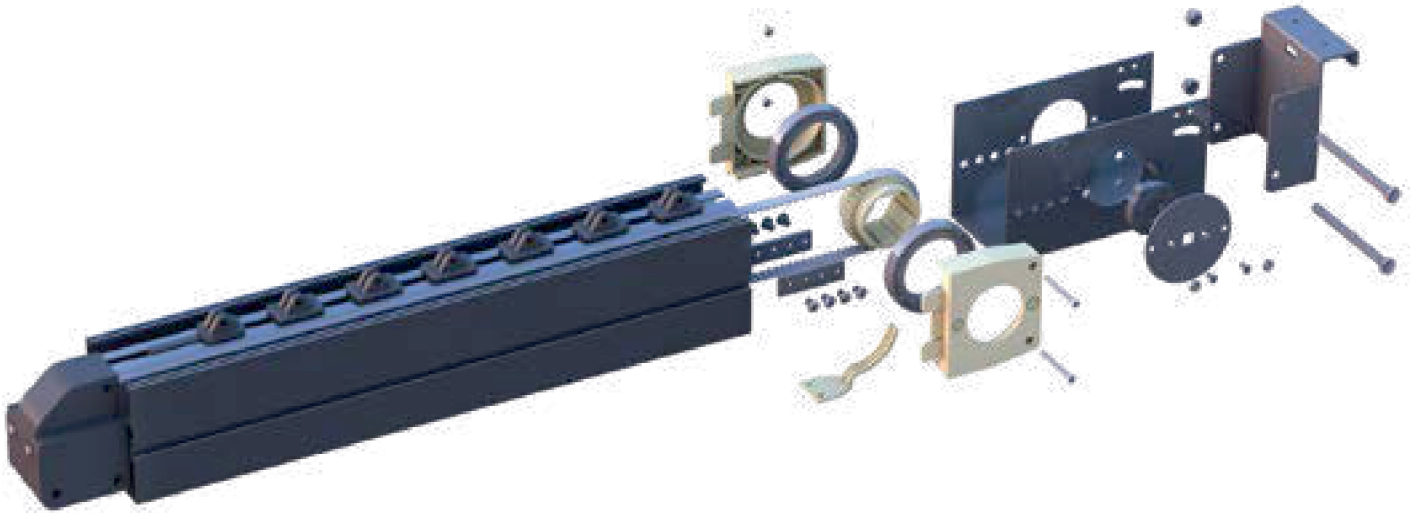
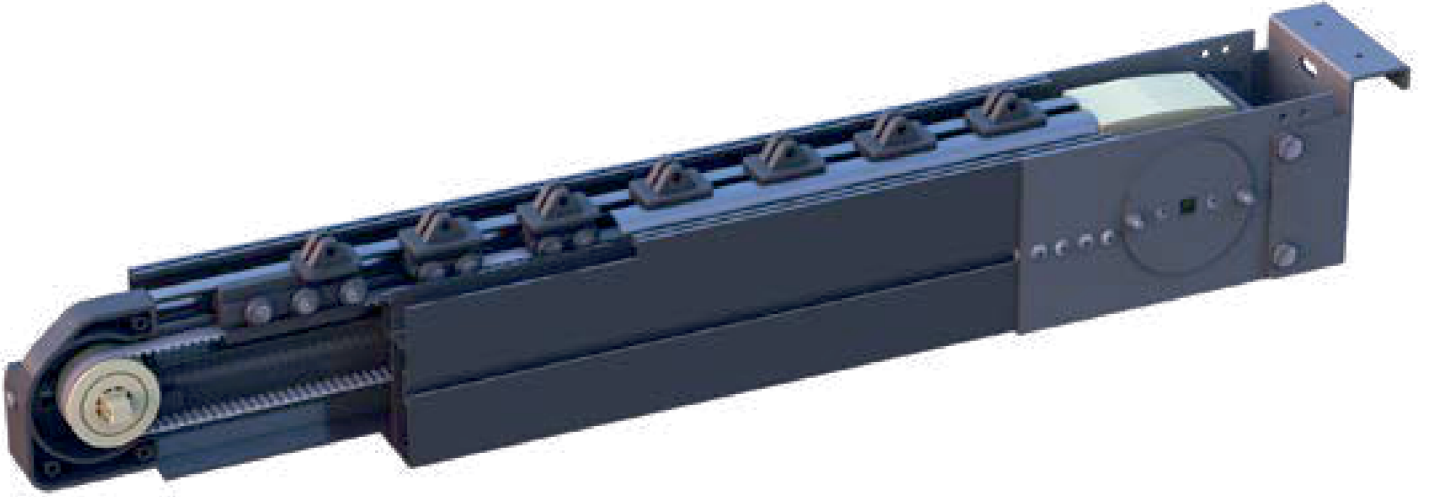

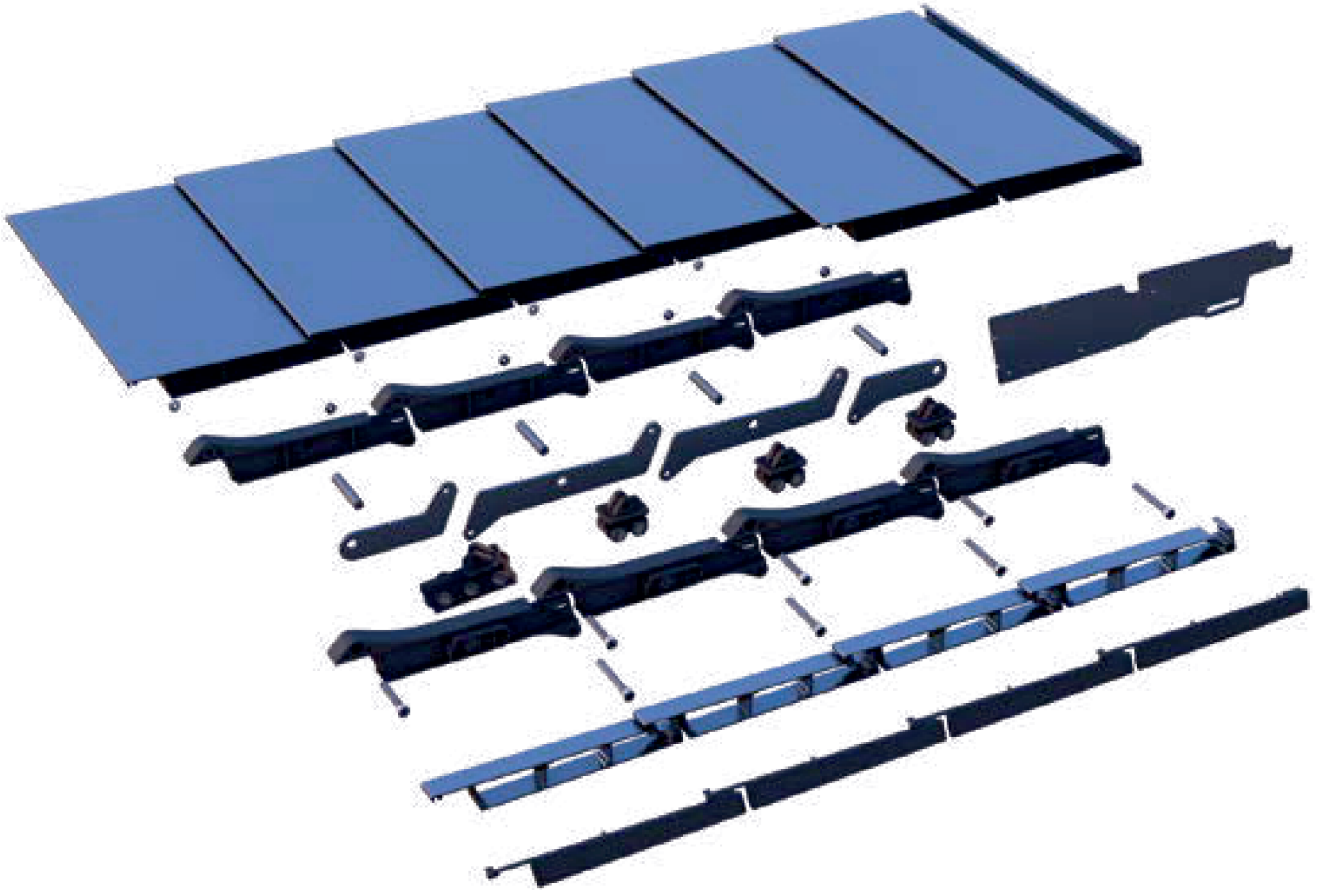

**SÜRME CAM SİSTEMİ**  
*Sliding Glass System*





**3'lü Yan Dikme**  
*3 Side Sewing*

**Product Code: YNG-2961**

**Weight kg/m: 0,710**  
( 74 x 35,5 x 1,7mm )



**4'lü Yan Dikme**  
*4 Side Sewing*

**Product Code: YNG-2962**

**Weight kg/m: 0,810**  
( 96 x 35,5 x 1,7mm )



**5'li Yan Dikme**  
*5 Side Sewing*

**Product Code: YNG-2963**

**Weight kg/m: 0,910**  
( 117 x 35,5 x 1,7mm )



**6'lı Yan Dikme**  
*6 Side Sewing*

**Product Code: YNG-2964**

**Weight kg/m: 1,010**  
( 138 x 35,5 x 1,7mm )



**Üçlü Alt Ray**  
*Triple Bottom Rail*

**Product Code: YNG-2869**

**Weight kg/m: 0,696**  
( 64 x 20 x 1,8mm )



**Dörtlü Alt Ray**  
*Quad Bottom Rail*

**Product Code: YNG-2870**

**Weight kg/m: 0,894**  
( 85,5 x 20 x 1,8mm )



**Beşli Alt Ray**  
*Five Bottom Rail*

**Product Code: YNG-2871**

**Weight kg/m: 1,089**  
( 106 x 20 x 1,8mm )



**Altılı Alt Ray**  
*Six Bottom Rail*

**Product Code: YNG-2872**

**Weight kg/m: 1,287**  
( 128 x 20 x 1,8mm )



**10mm Sürme Alt Kanat**  
*10mm Sliding Lower Wing*

**Product Code: YNG-2868**

**Weight kg/m: 0,825**  
( 74 x 17 x 1,7mm )



**10mm Cam Tutucu**  
*10mm Glass Holder*

**Product Code: YNG-2670**

**Weight kg/m: 0,230**  
( 19,5 x 16 x 1,35mm )



**6.7x550 Kıl Fitol**  
*6.7x550 Bristle Wick*

**Product Code: YNG-14**

**Roll: 375 mt.**  
**Box Piece: 1500 mt.**



**6.7x1200 Kıl Fitol**  
*6.7x1200 Bristle Wick*

**Product Code: YNG-24**

**Roll: 175 mt.**  
**Box Piece: 700 mt.**



**Sürme Cam Fiteli Epdm Eco**  
*Sliding Glass Seal Epdm Eco*

**Product Code: YNG-18**

**Roll: 100 mt.**



**Sürme Teker Proili Çekici Kapağı Eco**  
*Sliding Wheel Proile Tractor Cover Eco*

**Product Code: YNG-19**

**Box Piece: 100**



**Sürme Teker Proili Sonlama Kapağı Eco**  
*Sliding Wheel Proile End Cap Eco*

**Product Code: YNG-20**

**Box Piece: 100**



**Sürme Teker Eco**  
*Sliding Wheel Eco*

**Product Code: YNG-21**

**Box Piece: 200**



**Sürme Cam Takozu Eco**  
*Sliding Glass Wedge Eco*

**Product Code: YNG-22**

**Box Piece: 100**



**Sürme Cam Kulbu Eco**  
*Sliding Glass Handle Eco*

**Product Code: YNG-23**

**Box Piece: 50**



**Sürme Cam Kulbu**  
*Sliding Glass Handle*

**Product Code: YNG-25**

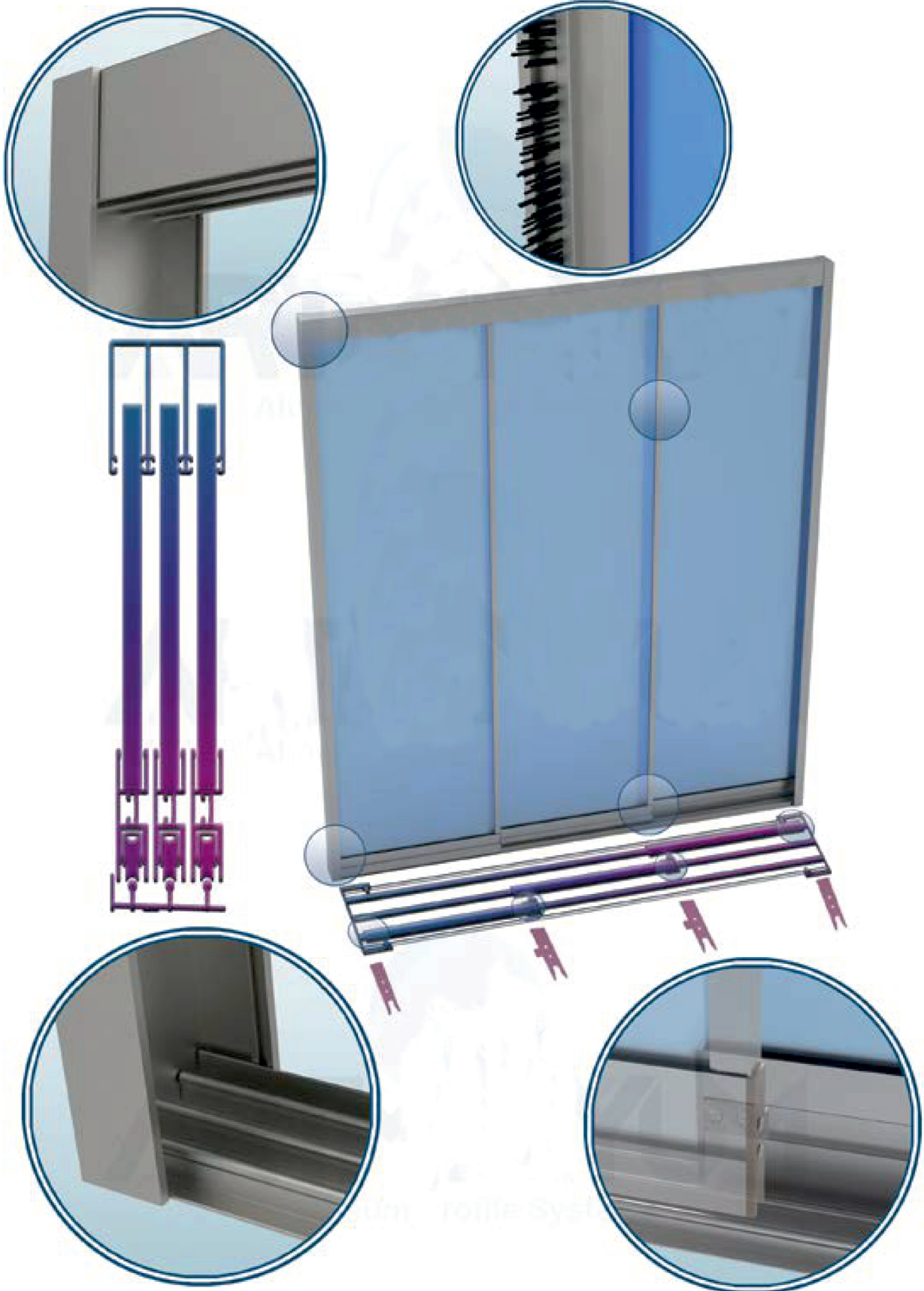





## PERGOLA SİSTEMLERİ



YOUNG // PERGOLA systems bring functionality and style to outdoor spaces, making them a fantastic option when you want to protect an outdoor area from rain, wind and heat all year round.

Retractable pergolas can be easily integrated into any outdoor space, making them perfect for commercial, residential applications. The highest comfort is ensured by a perfect automation system that can be remotely controlled, and a range of accessories that will enhance the pergola's use experience, in any part of the day.

Retractable awnings have become the most effective and convenient type of awning in use. As the name suggests, they can be retracted and extended whenever you require, thus you can protect it against harsh weather. For residential applications, a perfect way to increase the curb appeal of your building and provide you a relaxed outdoor atmosphere. It helps to save you money by making your home more energy-efficient. Blocking the path of sun rays can directly cool things down, thus in turn save. It can also reduce heat gain and cut down electric bill as discussed below respectively. For commercial applications while increasing outdoor usage area, helps owners to welcome more guests and feel them more comfortable and enjoy with their meals. It means more profit and improving satisfaction level of guests all year round. With this feature, retractable pergola is not the choice, it is an essential product.

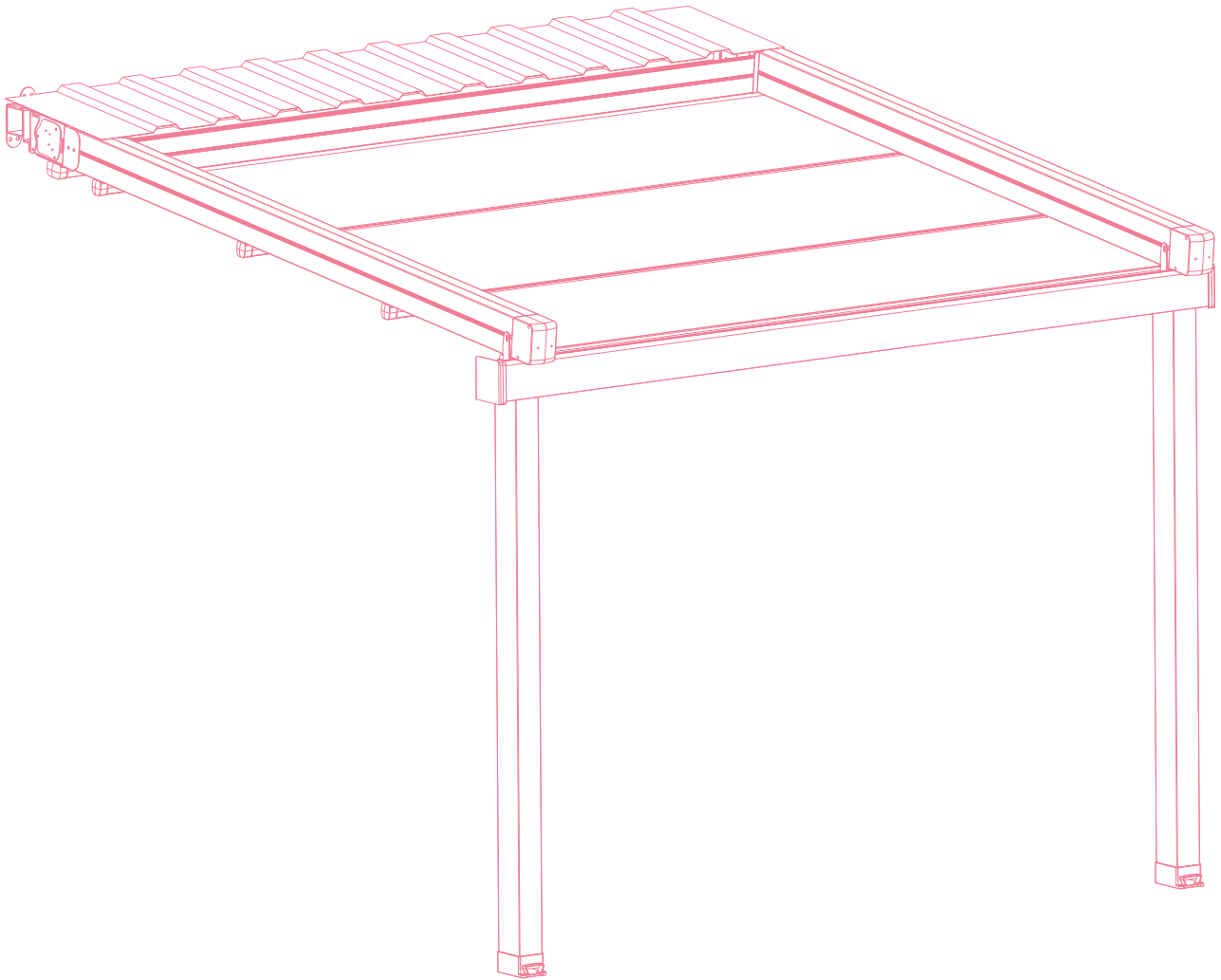

At 4 modules Pergola to provide smooth extension on fabric, two synchronised motor use recommended by YOUNG.

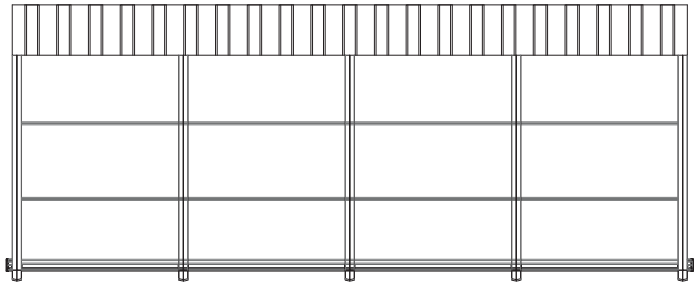
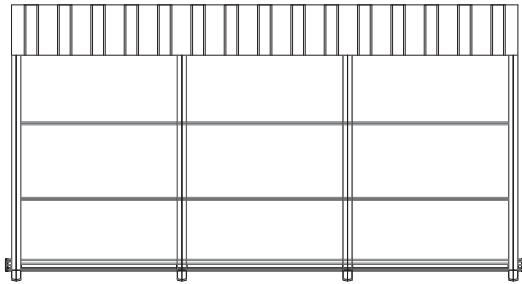
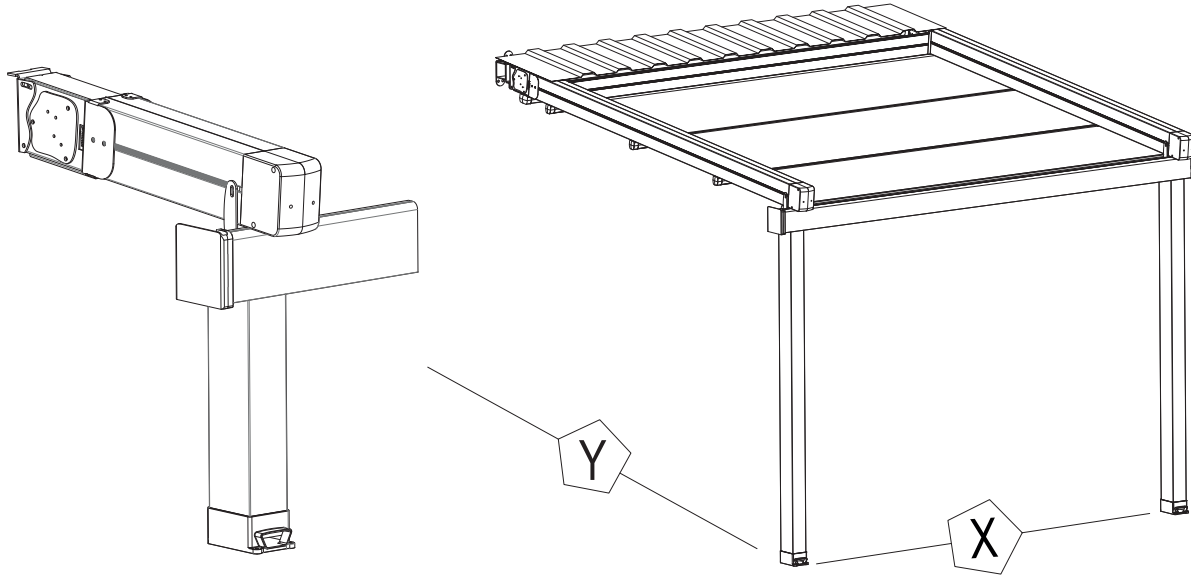

3 Module [Thin Rail 8x13cm]		
	Width Min.	Width Max.
X	600 cm	900 cm
Y	200 cm	500 cm

4 Module [Thin Rail 8x13cm]		
	Width Min.	Width Max.
X	900 cm	1200 cm
Y	200 cm	500 cm

3 Module [Thick Rail 11x15cm]		
	Width Min.	Width Max.
X	600 cm	900 cm
Y	200 cm	900 cm

4 Module [Thick Rail 11x15cm]		
	Width Min.	Width Max.
X	900 cm	1200 cm
Y	200 cm	800 cm

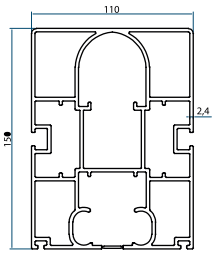

Profile No	kg/m
YNG-2001	7,168

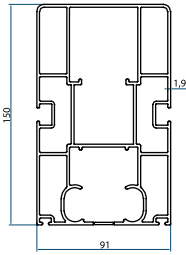

Profile No	kg/m
YNG-2052	5,217

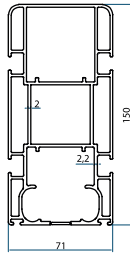

Profile No	kg/m
YNG-6413	4,655

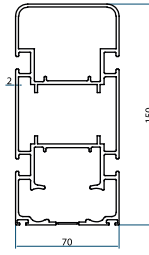

Profile No	kg/m
YNG-5922	4,212

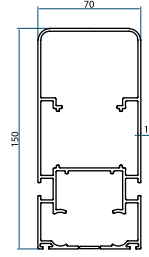

Profile No	kg/m
YNG-2156	3,217

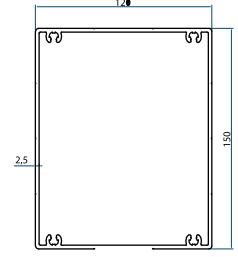

Profile No	kg/m
YNG-6569	3,994

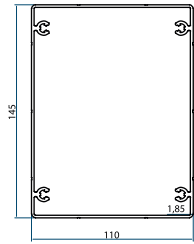

Profile No	kg/m
YNG-2111	3,044

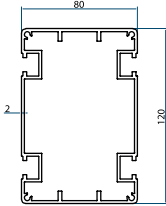

Profile No	kg/m
YNG-5936	3,032

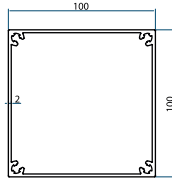

Profile No	kg/m
YNG-6565	2,463

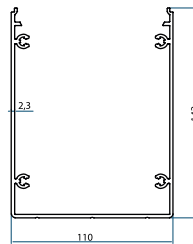

Profile No	kg/m
YNG-2301	3,003

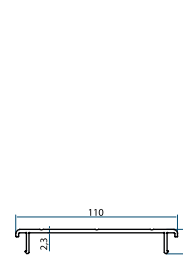

Profile No	kg/m
YNG-2302	0,846

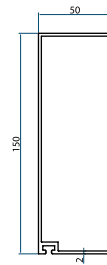

Profile No	kg/m
YNG-1517	3,994

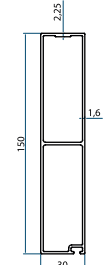

Profile No	kg/m
YNG-37025	3,994

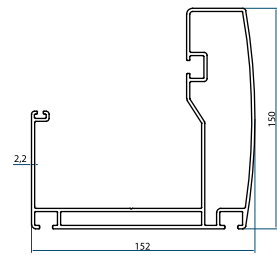

Profile No	kg/m
YNG-2078	4,398

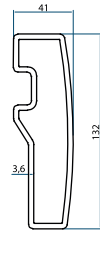

Profile No	kg/m
YNG-2281	3,246

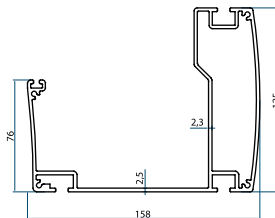

Profile No	kg/m
YNG-5935	3,918

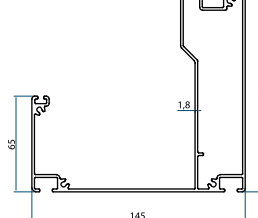

Profile No	kg/m
YNG-2770	3,150

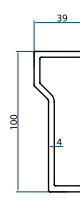

Profile No	kg/m
YNG-6536	2,618

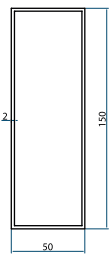

Profile No	kg/m
YNG-1517	2,195

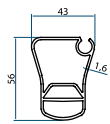

Profile No	kg/m
YNG-5661	1,119

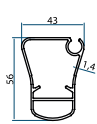

Profile No	kg/m
YNG-37156	0,845

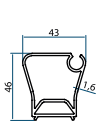

Profile No	kg/m
YNG-37033	0,927

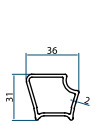

Profile No	kg/m
YNG-5477	0,618

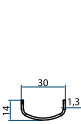

Profile No	kg/m
YNG-37034	0,163

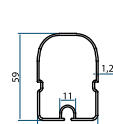

Profile No	kg/m
YNG-2653	0,700

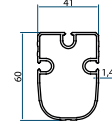

Profile No	kg/m
YNG-37153	0,937

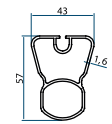

Profile No	kg/m
YNG-37225	0,948

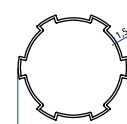

Profile No	kg/m
YNG-5312	1,100

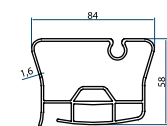

Profile No	kg/m
YNG-5410	1,830

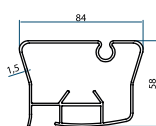

Profile No	kg/m
YNG-37200	1,520

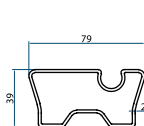

Profile No	kg/m
YNG-5478	1,309

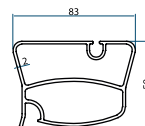

Profile No	kg/m
YNG-5271	1,867

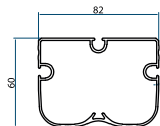

Profile No	kg/m
YNG-37216	1,280

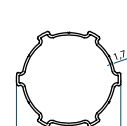

Profile No	kg/m
YNG-37100	1,074

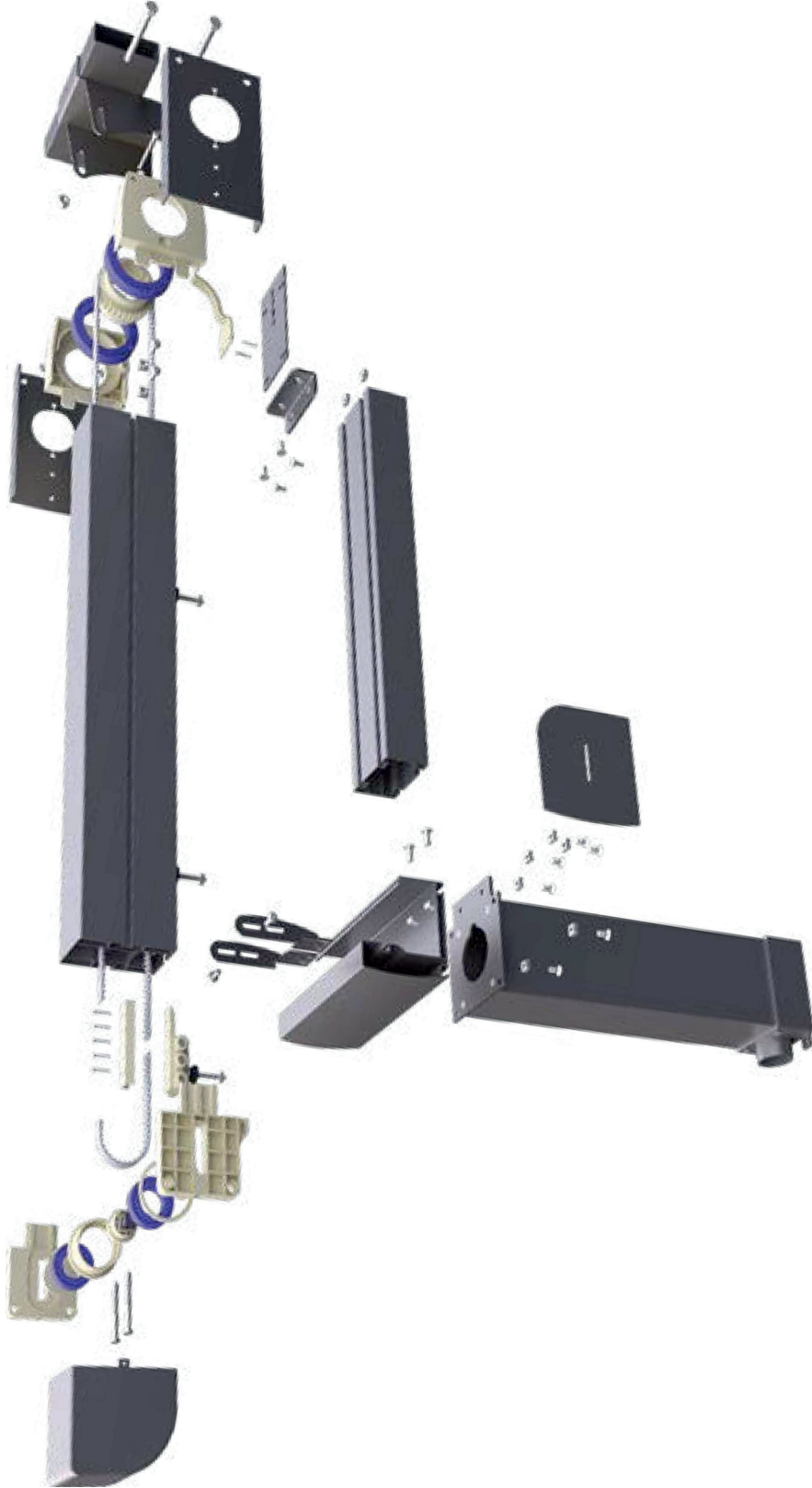











- 24mm Çift Cam ve 8mm Tek Cam Kullanabilme
- Kapaklı Motor Kutusu ile Kolay Montaj
- Kayışlı ve Zincirli Kullanıma Uygun
- Ayrılabilir Dikme Ayaklarıyla Hızlı Kanat Montajı

- Kanal Gizleme Kapakları
- Kertmesiz Bağlı ile Kolay İmalat
- Alüminyum Motor Borusu



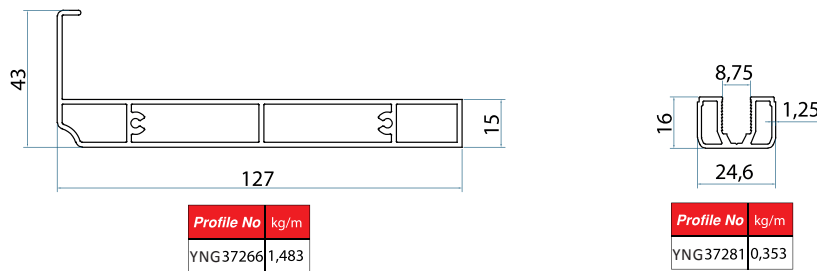
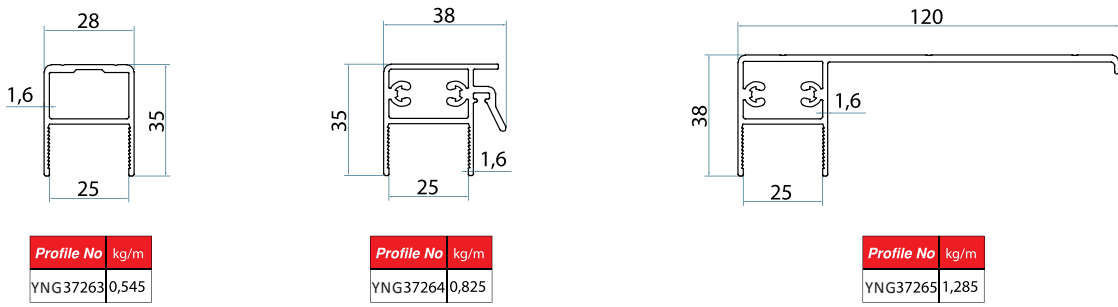
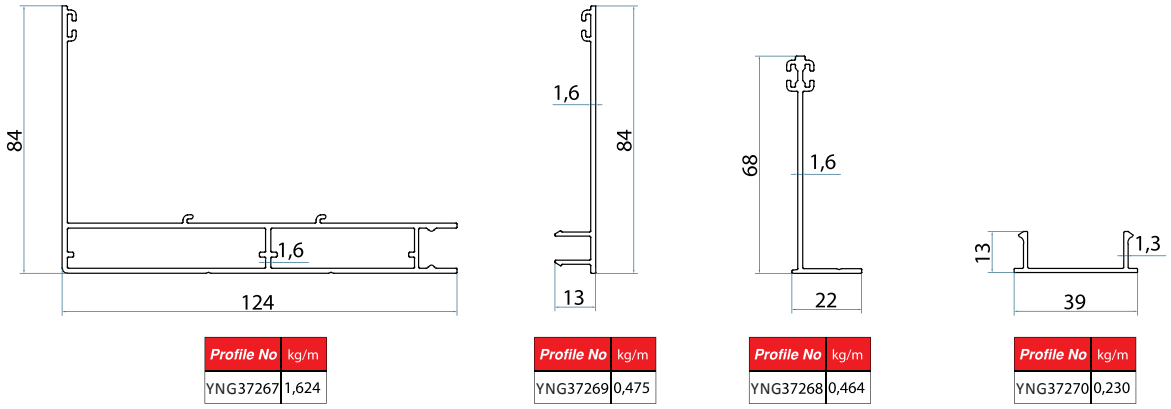
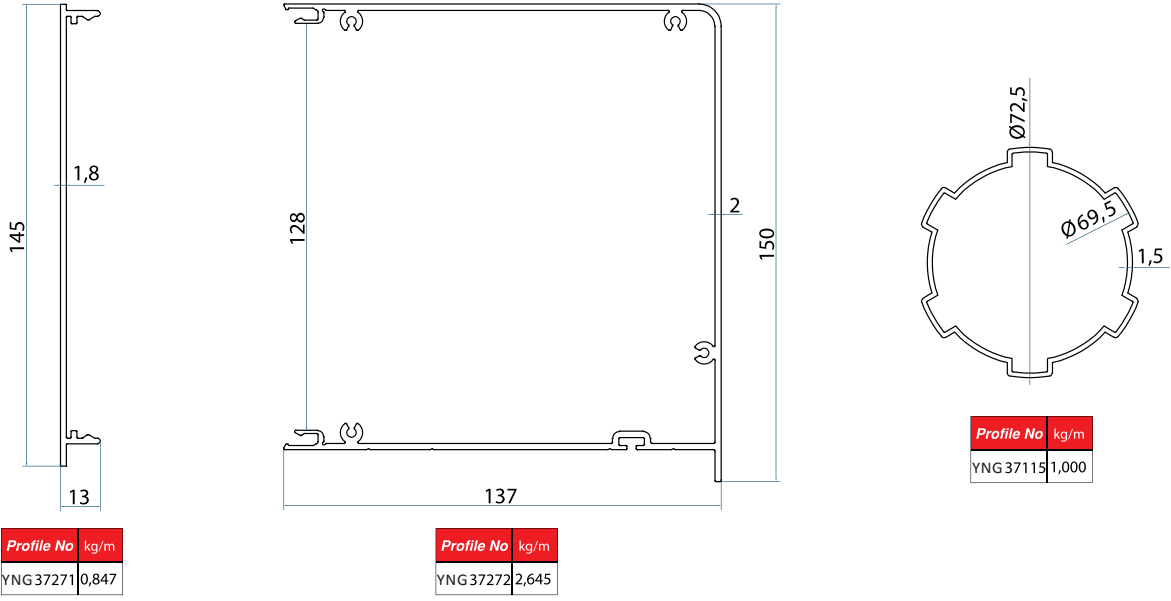



**24mm Trabzan Profili**  
*24mm Handrail Profile*

Product Code:YNG-37265

Weight kg/m: 1,285  
(38 x 120 x 1,6mm)



**24mm Dikme ve Alt Profili**  
*24mm Sewing and Bottom Profile*

Product Code:YNG-37263

Weight kg/m: 0,545  
(28 x 35 x 1,6mm)



**24mm Çekici Profili**  
*24mm Attractive Profile*

Product Code:YNG-37264

Weight kg/m: 0,825  
(38 x 35 x 1,6mm)



**8mm Adaptör**  
*8mm Adapter*

Product Code: YNG 37281

Weight kg/m: 0,353  
(24,6 x 16,1 x 1,25mm)



**Ray İç Tırnak Profili**  
*Ray Inner Nail Profile*

Product Code: YNG-37268

Weight kg/m: 0,464  
(22 x 68 x 1,6mm)



**Ray Dış Tırnak Profili**  
*Ray External Nail Profile*

Product Code: YNG-37269

Weight kg/m: 0,475  
(13 x 84 x 1,6mm)



**Ray Kapak Profili**  
*Rail Cover Profile*

Product Code: YNG-37270

Weight kg/m: 0,230  
(13 x 39 x 1,3mm)



**Tüp Motor Borusu**  
*Tube Motor Profile*

Product Code: YNG-37115

Weight kg/m: 1  
(72,5 x 1,5mm)



**Motor Kutusu Profili**  
*Engine Box Profile*

Product Code:YNG-37272

Weight kg/m: 2,645  
(138 x 160 x 2mm)



**Motor Kutusu Kapak Profili**  
*Engine Box Cover Profile*

Product Code:YNG-37271

Weight kg/m: 0,847  
(13 x 145 x 1,8mm)



**Ray Profili**  
*Rail Profile*

Product Code:YNG-32267

Weight kg/m: 1,624  
(84 x 124 x 1,6mm)



**Alt Baza Profili**  
*Lower Base Profile*

Product Code:YNG-37266

Weight kg/m: 1,483  
(15 x 127 x 43 x 1,5mm)



TERRASSE STRUCTURE  
ALUMINIUM TERRASSE

# Young

**YOUNG ALÜMİNYUM YAPI TİCARET LİMİTED ŞİRKETİ**  
**CEMİL MERİÇ MAH. İSTİKLAL CAD. NO:29**

**ÜMRANIYE / İSTANBUL**

**Tel: +90 216 6502453**

**[www.youngaluminum.com](http://www.youngaluminum.com)**

**[youngaluminum@gmail.com](mailto:youngaluminum@gmail.com)**

**YOUNG**

alüminyum

[www.youngaluminum.com](http://www.youngaluminum.com)